

DURAMAX

Demountable Keel Cooler

- ▷ Efficient 90/10 Copper-Nickel Spiral Tubes
- ▷ Replaceable Components Extend Service Life
- ▷ Expandable Cooling Capacity

STEEL HULLED
VESSELS ONLY



PRODUCT INFORMATION AND SELECTION GUIDE

DURAMAX MARINE®



Demountable Keel Coolers. For Superior Heat Transfer and Design Flexibility for Steel-Hulled Vessels.

The Duramax® Demountable Keel Cooler System is the economical outboard cooling solution with benefits not found in other forms of closed and open heat exchange systems. It is a closed cooling system designed to cool main and auxiliary engines on steel-hulled vessels.

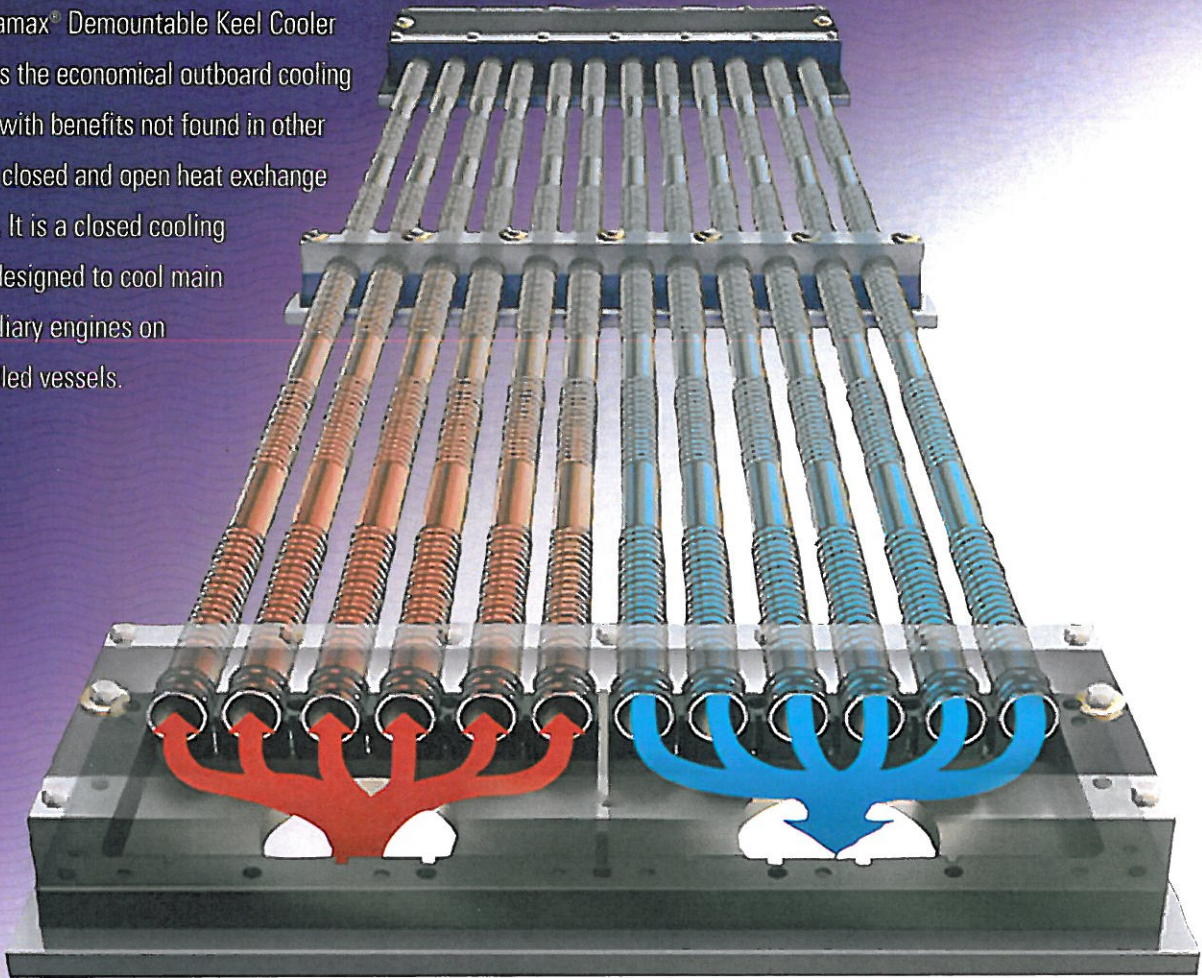

Provides many benefits for both shipbuilders and owners.

Superior heat transfer with 90/10 copper-nickel spiral tube design

- ▶ Easily expandable cooling capacity if you need to re-power
- ▶ Modular design for simple and flexible installation
- ▶ Can combine multiple cooling circuits
- ▶ Lower installation costs than steel channel coolers
- ▶ Tubes conform to most hull curvatures
- ▶ Demountable tubes and individual parts are in stock for quick, easy repair
- ▶ No through-hull fittings speeds installation
- ▶ Eliminates need for inboard seachest
- ▶ Built to match vessel's internal plumbing
- ▶ Covers wide range of cooling capacities
- ▶ Excellent resistance to corrosion and erosive effects of seawater
- ▶ Low profile design provides minimal stand-off from hull

Our 90/10 copper-nickel spiral tube is the heart of the cooler system.

Excellent heat transfer.

The unique design of our tubes enhances the surface and creates a turbulent flow to boost the tubes' heat transfer capabilities. In fact, the forced helical motion of the coolant flow extracts heat almost twice as fast as a hull-welded steel channel cooler. As a result, Duramax® Demountable Keel Coolers take less hull space for maximum cooling.

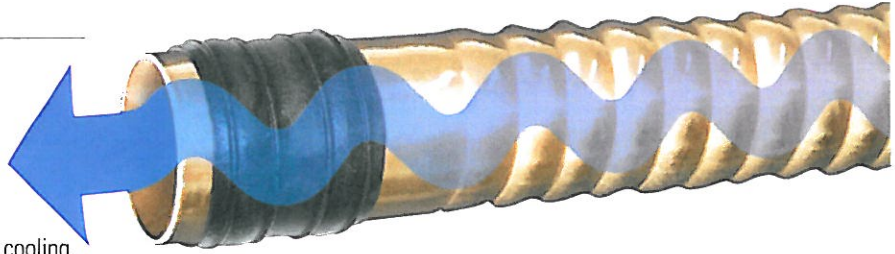

Light weight and flexible.

Our 90/10 copper-nickel spiral tubes are tough but lightweight. They afford the bending strength of thicker tubing, yet allow the flexure needed to follow hull contours without developing significant stress.

Resists corrosion.

Copper-nickel is naturally resistant to the effects of biological marine fouling, plus all components on our keel cooler have excellent resistance to corrosion and erosive effects of seawater.

Cool multiple heat sources on the same Demountable Keel Cooler.

Not only can your main engine be efficiently cooled with one Duramax® Demountable Keel Cooler, so can your generators, winch engines, air conditioner, compressors and thrusters.

Through the use of internal partitions or "separators", coolant flow can be divided into separate cooling circuits. The flow is controlled to optimize internal coolant velocities, depending on the cooling needs of the different heat sources. Each cooling circuit functions as an independent cooler.

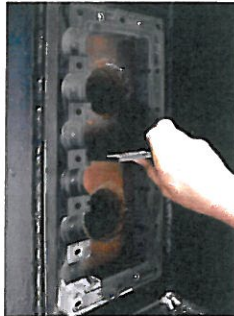

Engineered to match cooling requirements.

Depending on your specific needs, tube banks can be custom designed in single-bank units of four, six and twelve tube, or in double-bank units of eight, twelve or twenty-four tube.

Expandable cooling capacity to re-power.

If you need to re-power or add additional heat sources to your vessel, an additional bank or level of tubes can be added to a single bank system to double the cooling capacity.

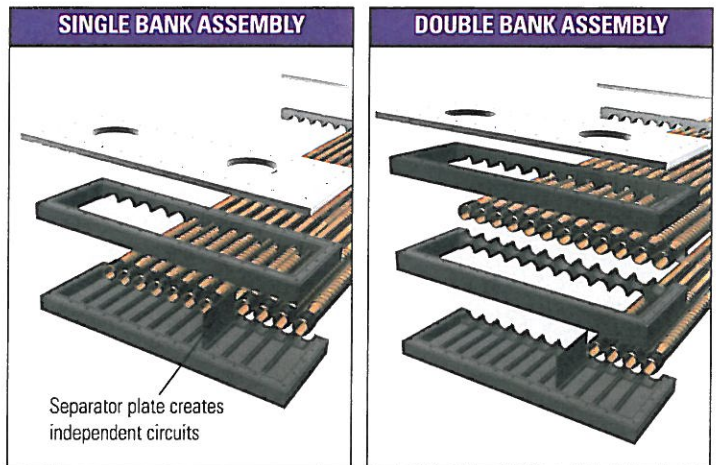

Duramax® Demountable Cooler vs. Fabricated Channel Steel Cooler



Costs less to install and operate.

A 1,200 lb. Demountable Cooler could produce the same amount of cooling as a 39,000 lb. channel steel system. This translates to:

- Reduced labor and material costs
- Smaller unit needed to cool same heat source
- Reduced drag and weight reduces operating costs

Easier to repair.

Unlike steel channel systems, the Duramax® Demountable Keel Cooler is easy to maintain. If an individual tube suffers damage it can quickly be replaced from our in stock parts. Also, tubes are easy to clean using high pressure water whenever necessary.

Custom Engineered Components For Superior Performance.

Every heat exchange application is unique. Different vessels, operating conditions, engines and equipment all require a custom engineered solution. The Duramax® Demountable Keel Cooler is an economical and versatile system that is designed to match your specific cooling need. Depending on the cooling requirements of the application, the Cooler can be engineered as a single-bank or a double-bank as shown here.

INLETS AND OUTLETS

Inlet and outlet holes can be specified at the same end or opposite end of the cooler, depending on your vessel's plumbing requirements.

STUD PLATES

3/4" Thick mild steel (SAE 1010-1020) stud plates are welded to the hull. They are supplied tapped with 3/8" 18-8 stainless steel bolts and washers for mounting the assembly. There are no through-hull fittings, and thus no internal seachests are required.

TOP DECK HEADS

Solid cast bronze frames have custom molded rubber bonded to surface for sealing and protection.

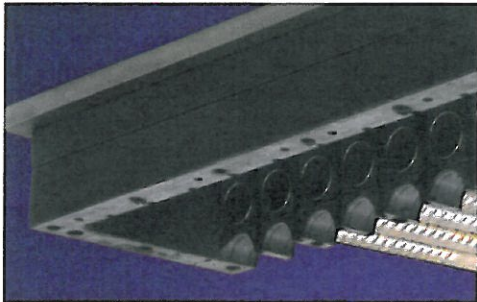

INTERDECKS

For double-bank units, rubber covered cast bronze interdecks are placed between upper and lower decks, providing an additional bank of heat-exchange tubes. Cooling capacity can thus be doubled with minimum cost and labor.

BOTTOM DECK HEAD

Rubber covered cast bronze bottom deck heads mate with top deck heads and interdecks to form an enclosed header with tubes clamped between.

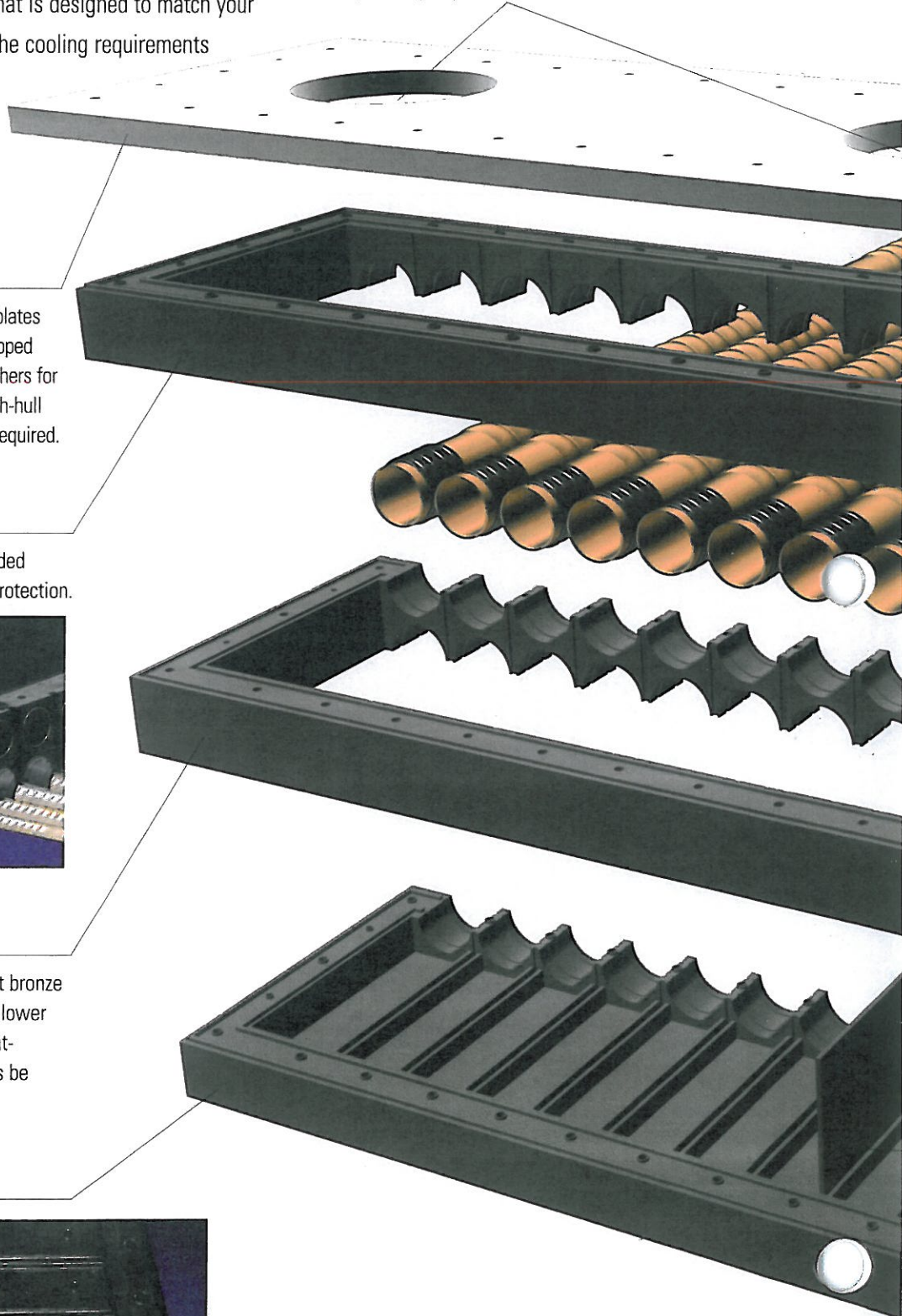
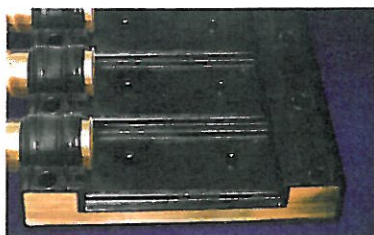



All Demountable Cooler Components are supplied predrilled and tapped with all required mounting hardware for easy assembly and attachment to the vessel's hull.

GROUNDING BRACKET

One grounding support bracket is supplied with each cooler and grounds the cooler to the hull. This bracket is made of solid bronze encapsulated in rubber with an exposed bronze area on its face, to facilitate grounding.



SPIRAL TUBES

The 90/10 copper-nickel spiral tubing is available in 1 ft. increments from 3 ft. to 20 ft. lengths.

TUBE SLEEVE SEALS

The rubber sleeve seals in this tongue and groove system have a raised beading which compresses to form a seal for watertight integrity.



SEPARATOR PLATE

Cool multiple heat sources on the same cooler. By splitting the cooler with solid partitions (separators), coolant flow can be divided and manipulated for higher and lower coolant velocities, depending on the cooling needs of different heat sources. Each cooling circuit functions as an independent cooler, eliminating the need for an additional cooler.

SUPPORT BRACKETS

Support brackets are supplied for tubing support between headers along with predrilled steel stud plates for mounting to hull. These brackets are solid steel encapsulated with rubber.

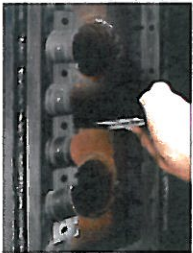
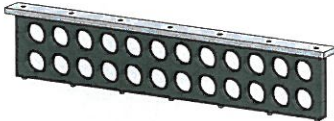

Engineered for fast, economical installation.

The Duramax® Demountable Keel Cooler pre-fitted system installs in one-fourth the time of fabricated channel steel cooler.

INSTALLATION METHOD OVERVIEW:

The Duramax® Demountable Keel Cooler is supplied with all hardware required for installation. All hardware and components have been predrilled and tapped to facilitate cooler installation.

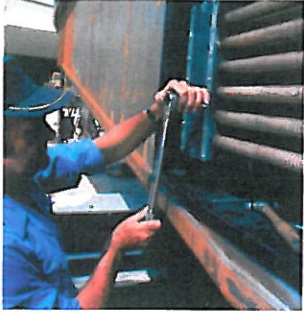

1. Weld the stud plates to the hull.
2. Join water pipes to the inlet/outlet of heat exchanger to openings in hull. This eliminates the need for through-hull fittings and inboard seachest.
3. Assemble the headers, tubes, dividers.
4. Tighten assembly bolts that fasten to pre-threaded holes in the stud plate.

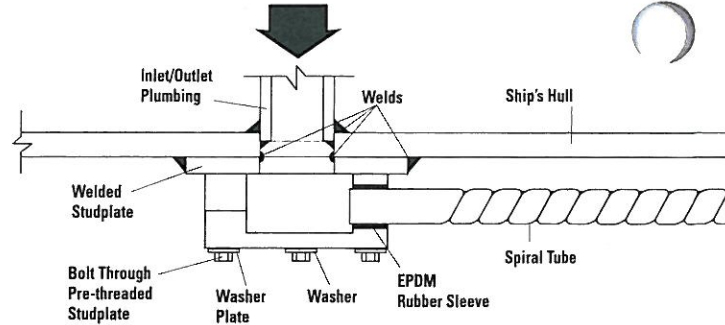

SEE OUR INSTALLATION GUIDE FOR COMPLETE DETAILS.

Demountable Coolers are flexible.

This allows for stress-free bending to accommodate the curvature of the hull.

Cooler can be installed on the exterior or recessed into the hull.

Protective shielding is recommended for all Demountable Cooler installations. The type of shield depends on service conditions and the location of the cooler on the vessel.

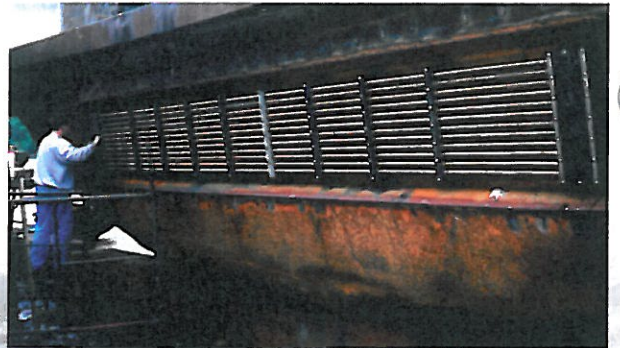

Trust Duramax Marine®. The heat exchange experts.

For over 40 years, Duramax Marine® has been designing and manufacturing innovative heat exchange products for the commercial marine industry. An 800,000 gallon keel cooler test facility was constructed where full-size keel coolers are tested under various real world conditions. This allows us to optimize our keel cooler design and continually improve our products.

Duramax Marine® has developed an exclusive, computerized keel cooler sizing system based on actual full-scale test results. This proprietary sizing system provides you with a correctly sized keel cooler for the intended application, reducing the risk of overheating.

So, have confidence knowing you are working with a dedicated group of heat exchange professionals.



Duramax Marine®
Testing Facility

For More Information or a Quotation, contact your
Duramax® Demountable Keel Cooler Expert.
Call 440-834-5400.
Or visit DuramaxMarine.com.

The Duramax® Demountable Keel Cooler is custom-sized for your vessel.

To correctly size a Demountable Keel Cooler for your specific application, we consider your vessel's external operating conditions, main engine information, generator and other factors used to determine your engine specifications and operational requirements.

The following information is required to correctly engineer and size your Duramax® Demountable Keel Cooler:

▷ **VESSEL OPERATING CONDITIONS**

Minimum Vessel Speed at Full Power _____ (knots/mph)
Maximum Ambient Sea Water Temperature _____ (C°/F°)
Maximum Hull Speed _____ (knots/mph)
Glycol in Coolant _____ (%)

▷ **HULL CONSTRUCTION**

(Spiral Tube Cooler Assembly for Steel Hull Vessels Only)

▷ **MAIN ENGINE**

Manufacturer _____
Model No. and Year _____
HP@RPM of Engine _____

▷ **GEARS** (Cooled by a Demountable Keel Cooler)

Twin Disc/ZF® Reintjes®
Other _____
Model No. and Year _____
Reintjes® Gear (provide water pump flow GPM) _____
System Pressure Drop Requirements _____

▷ **CIRCUITS COOLED**

Jacket Water After Cooler Combined Circuit

▷ **FOR LOW TEMP CIRCUITS** (After Cooler, Combined, LTA)

Specify low temp from cooler _____

▷ **GENERATOR**

Manufacturer _____
Model No. and Year _____
KW@RPM of Engine _____

▷ **OTHER HEAT SOURCES** (Pump, Thruster, Etc.)

Manufacturer _____
Model No. and Year _____

▷ **DEMOUNTABLE KEEL COOLER DESIGN PREFERRED**

Inlet/Outlet Location: (check one)
 Same End (double pass) Opposite Ends (single pass)

▷ **SPACE AVAILABLE (on hull)**

Maximum Length _____ Maximum Width _____